



HEX6325 全极低功耗磁阻霍尔

Feature

- MR+CMOS monolithic structure
- High sensitivity
 $B_{OP} = \pm 17\text{Gauss}$, $B_{RP} = \pm 14\text{Gauss}$
- Low power consumption
Average supply current $< 4.1\mu\text{A}$ (Typical)
- Wide operating temperature range
 $-40\sim 125^\circ\text{C}$
- Push-pull Output Mode
- RoHs compliant 2011/65/EU

Application:

- Position Detection
- Proximity Detection
- Speed Detection
- Flow meters including water meter, gas meter and heat meter

Product Description

The HEX6325 is a monolithic IC with built-in MR magneto-resistive element and CMOS switch. The IC internally includes a MR bridge, a voltage regulator for operation with supply voltage from 1.8V to 5.5V, a sleep/awake logic for low power consumption, small signal amplifier and Schmitt trigger comparator with dynamic offset cancellation, and a push-pull output.

When combined with a magnet, it becomes a non-contact switch with low current consumption, high sensitivity and reliability. A horizontal magnetic field parallel to the electrode of the package can be detected by an arbitrary polarity.

The HEX6325 is ideal for use to gather speed and detect position, particularly suited for applications that require accurate duty cycle or accurate edge detection and low power consumption such as speed detection in smart meters.

Pin definition

Name	Number	Description
VDD	1	Power Supply
OUT	2	Output Signal
GND	3	Ground

HEX6325ET (SOT-23 package)

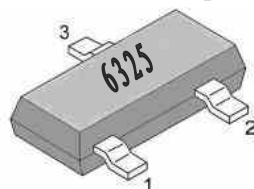

Name	Number	Description
NC	1	Not Connected
GND	2	Ground
NC	3	Not Connected
OUT	4	Output
VDD	5	Power

HEX6325 SN (SOT-553 package)

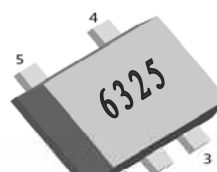



Family members

Part Number	Description
HEX6325ET	SOT-23(thin outline) package ,tape and reel packaging(3000pcs/bag)
HEX6325SN	SOT-553 package, tape and reel packaging (3000pcs/bag)

Block Diagram

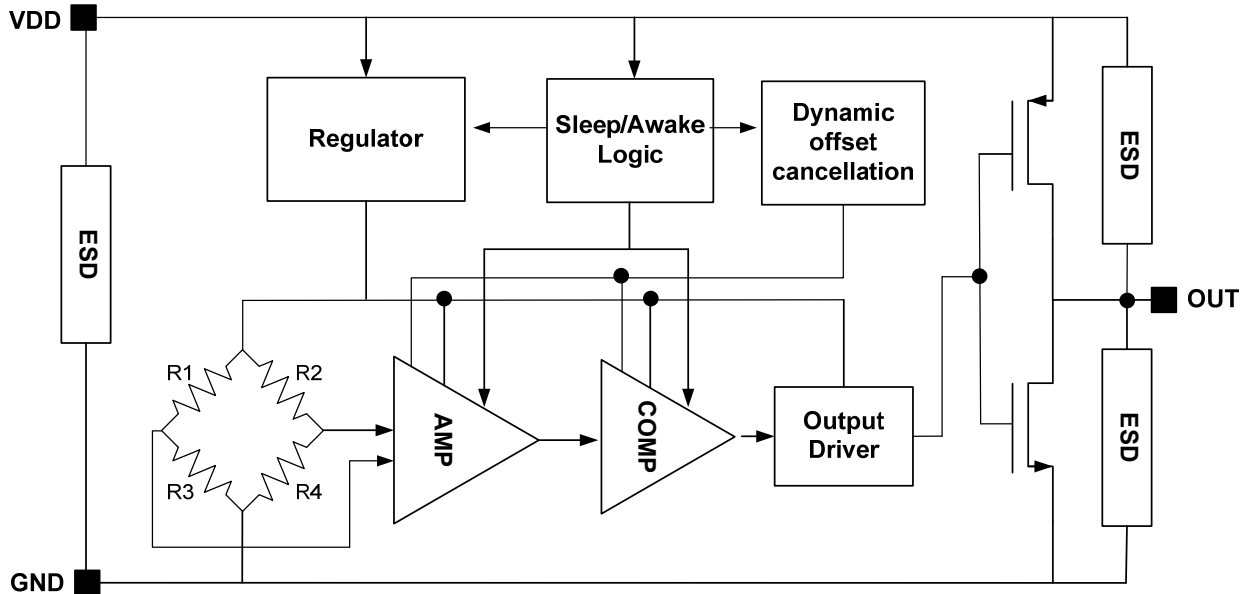

Function Description

Definition of magnetic parameters

B_{OP} : Operating point, magnetic flux density that sets the digital output to logic HIGH.

B_{RP} : Release point, magnetic flux density that sets the digital output to logic LOW.

B_{HYST} : Hysteresis window, $|B_{OP} - B_{RP}|$

Definition of Switching Function

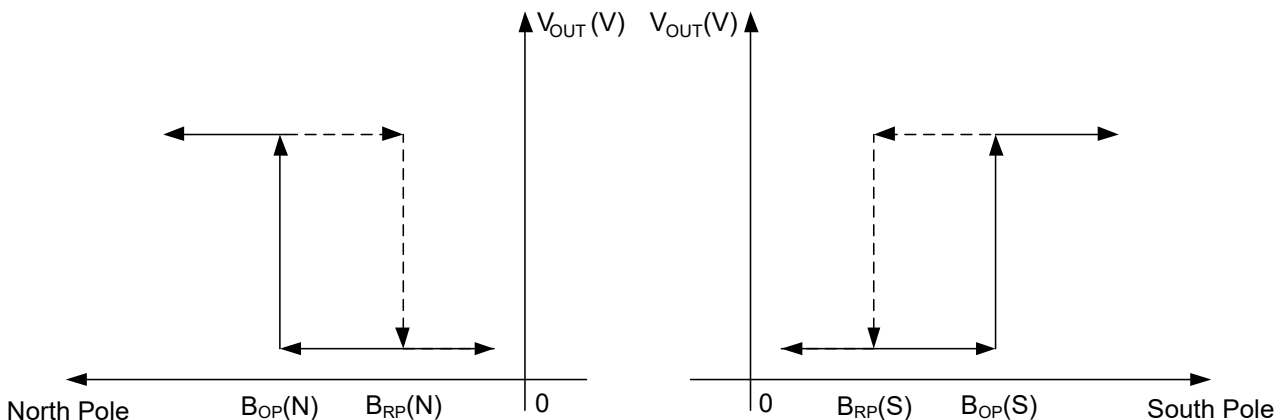



Drawing Illustrating Detectable Magnetic Field

HEX6325ET (SOT-23 package)

Front view

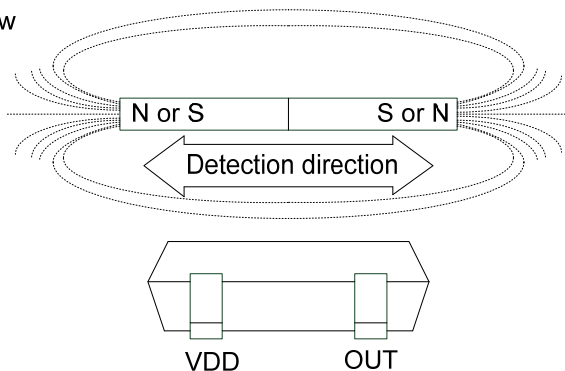

Top view

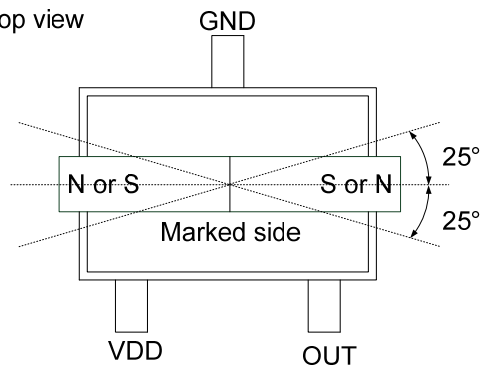

HEX6325SN (SOT-553 package)

Front view

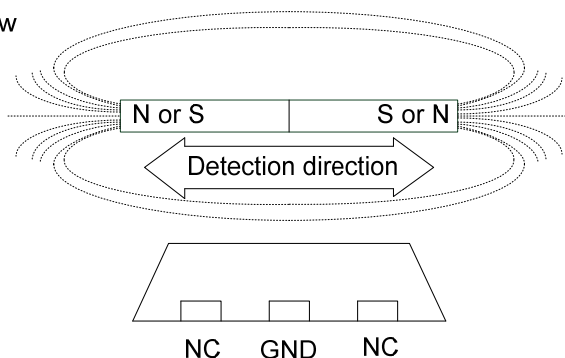

Top view

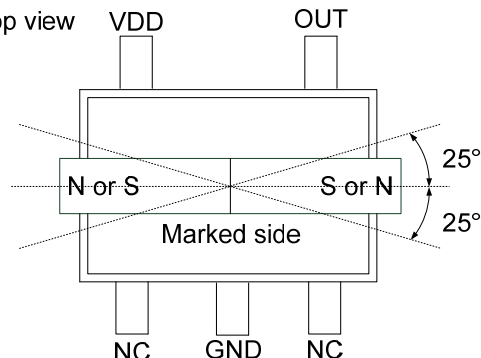

Detection of magnetic field

To operate the MR switch, the magnetic field should be applied to the sensor with sufficient magnetic flux density and correct direction. HEX6325 series are designed to put out logic HIGH level when the horizontal direction magnetic field is applied in parallel to the marked side of sensor, with sufficient magnetic flux (B_{OP} value) regardless of polarity of magnet. HEX6325 series detect the horizontal direction magnetic field, and it does not respond to vertical direction magnetic field.



Absolute Maximum Rating

Absolute maximum ratings are limiting values to be applied individually, and beyond which the serviceability of the circuit may be impaired. Functional operability is not necessarily implied. Exposure to absolute maximum rating conditions for an extended period of time may affect device reliability.

Absolute maximum ratings: all voltages listed are referenced to GND

Symbol	Parameters	Min	Max	Unit
V_{DD}	Supply Voltage	-0.5	7	V
I_{OUT}	Continuous Output Current	-	10	mA
V_{OUT}	Output voltage	-0.5	7	V
B	Magnetic flux	-	3000	Gauss
T_A	Operating Temperature Range	-40	+125	°C
T_S	Storage Temperature Range	-50	+150	°C

Electrical Characteristics

At $T_A = -40^{\circ}\text{C}$ to 125°C , $V_{DD} = 1.8\text{V}$ to 5.5V (Unless other specified)

Symbol	Parameters	Test Conditions	Min	Typ	Max	Units
V_{DD}	Supply voltage	Operating	1.8	-	5.5	V
I_{DD}	Supply current	$V_{DD} = 3.6\text{V}$	-	4.1	7.0	μA
V_{OL}	Output low voltage	$I_{OUT} = 5\text{mA}$, $ B < B_{RP} $	-	-	0.2	V
V_{OH}	Output high voltage	$I_{OUT} = 5\text{mA}$, $ B > B_{OP} $	$V_{DD} - 0.3$	-	-	V
F _{SW}	Switching frequency	$V_{DD} = 3.6\text{V}$	-	900	-	HZ
T_{AW}	Awake Time	$V_{DD} = 3.6\text{V}$	-	12	-	μs
T_{SL}	Sleep Time	$V_{DD} = 3.6\text{V}$	-	1.11	-	ms
D.C.	Duty Cycle	$V_{DD} = 3.6\text{V}$	-	1.1	-	%
T_{PO}	Power on time		-	-	100	μs
ESD	Electro-Static Discharge	AEC-Q100	Class 3			

Magnetic Characteristics

At $V_{DD} = 1.8\text{V}$ to 5.5V

Symbol	Parameters	Test Conditions	Min	Typ	Max	Units
B_{OP}	Magnetic operating point	At $T_A = 25^{\circ}\text{C}$	± 7	± 17	± 27	Gauss
B_{RP}	Magnetic release point	At $T_A = 25^{\circ}\text{C}$	± 4	± 14	± 24	Gauss
B_{HYST}	Hysteresis window	At $T_A = 25^{\circ}\text{C}$, $ B_{OP} - B_{RP} $	1	3	6	Gauss



Application Information

Typical Application Circuit

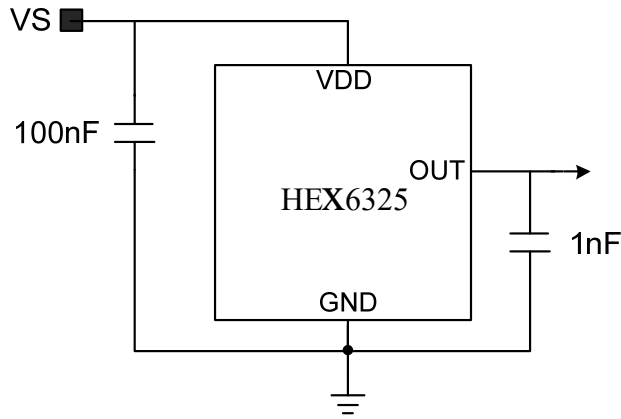

Operating Waveform

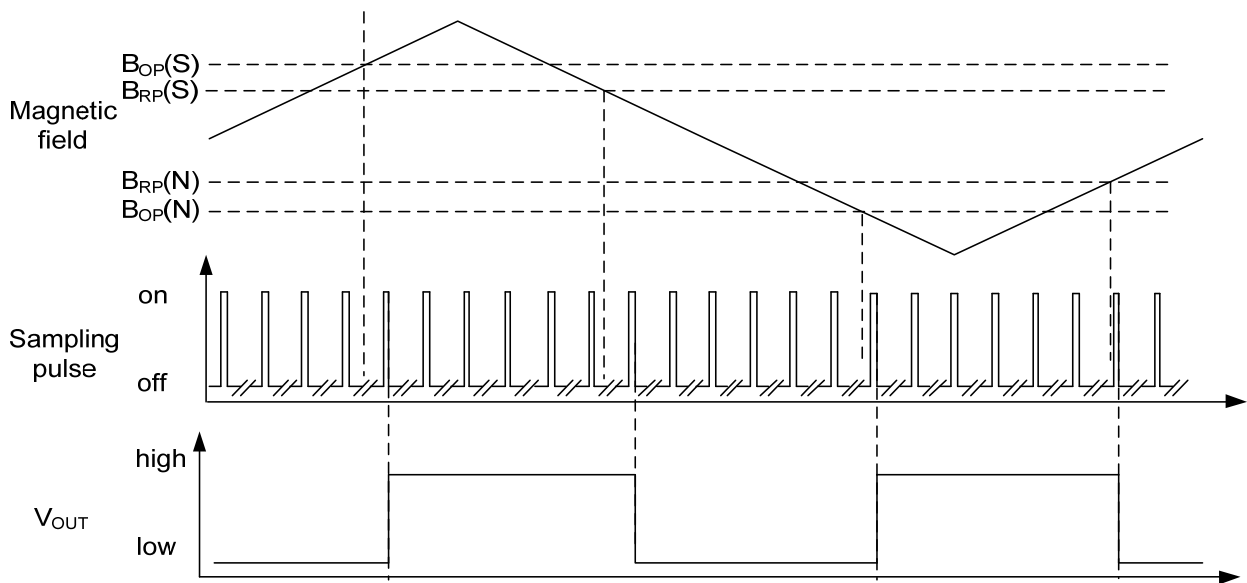

Power-On Waveform

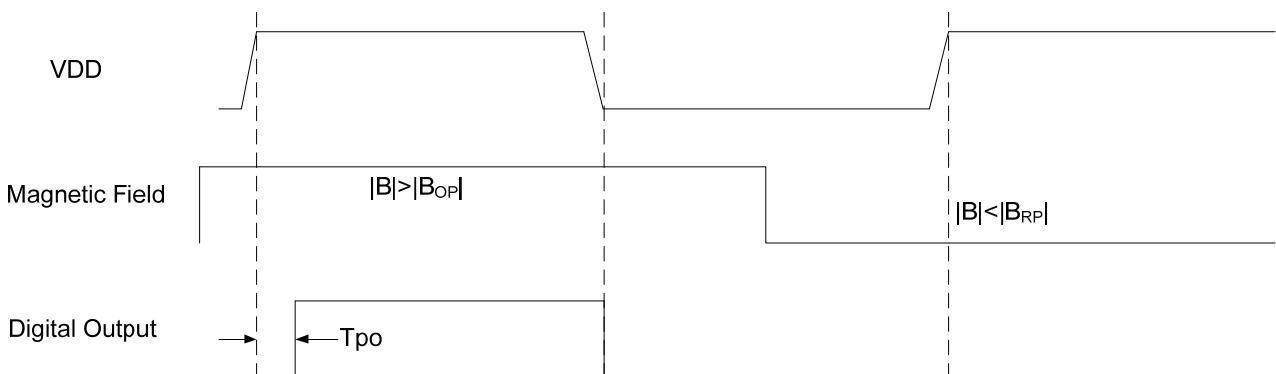

Note: V_{DD} rise time < 1us, T_{po} is the time from V_{DD} becoming stable to output becoming valid.



Characteristic Performance

Average Supply Current versus Temperature

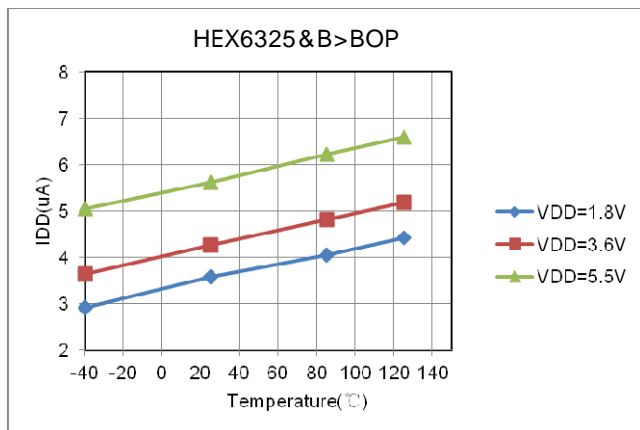

Magnetic Characteristics versus Temperature (V_{DD}=3.6V)

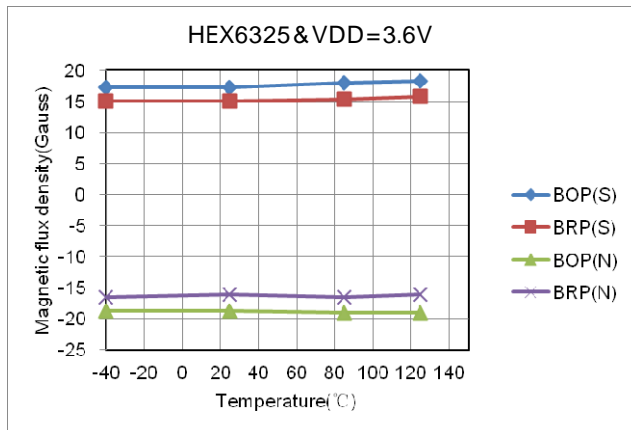

Magnetic Characteristics versus Supply Voltage (T_A=25°C)

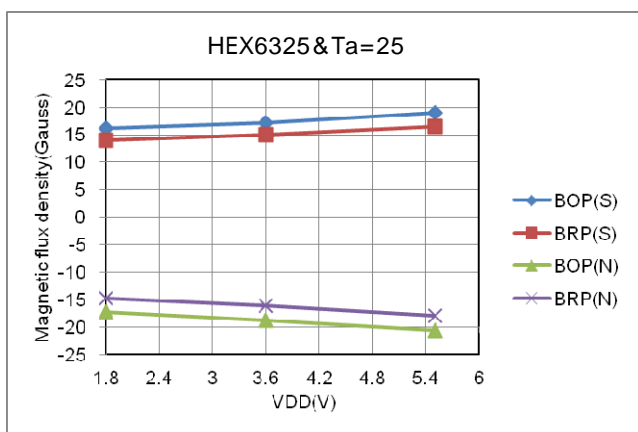

Hysteresis window versus Temperature (V_{DD}=3.6V)

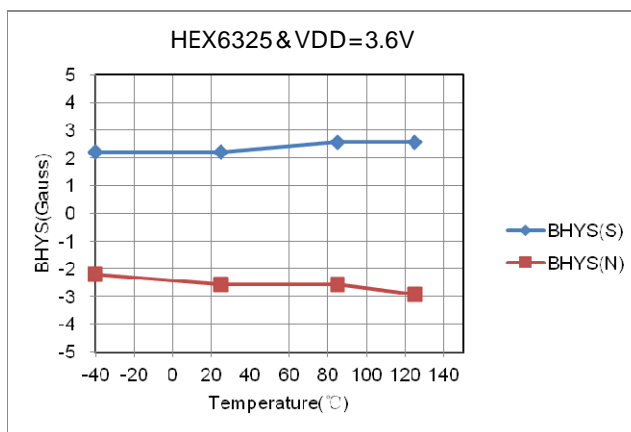



**PACKAGE DESIGNATOR
(HEX6325ET) SOT-23**

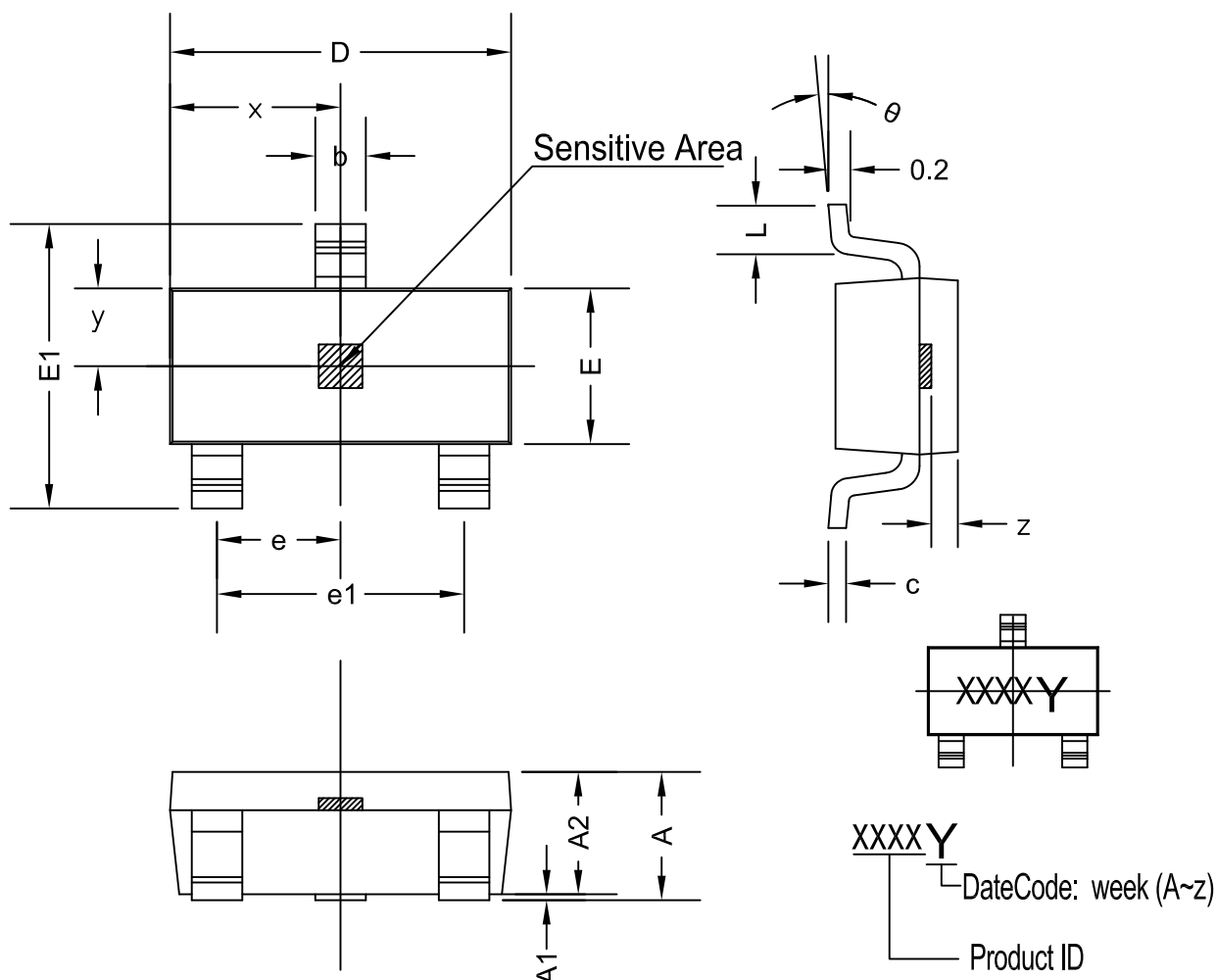

Symbol	Dimensions in Millimeters		Dimensions in Inches	
	Min	Max	Min	Max
A	0.900	1.150	0.035	0.045
A1	0.000	0.100	0.000	0.004
A2	0.900	1.050	0.035	0.041
b	0.300	0.500	0.012	0.020
c	0.080	0.150	0.003	0.006
D	2.800	3.000	0.110	0.118
E	1.200	1.400	0.047	0.055
E1	2.250	2.550	0.089	0.100
e	0.950 TYP		0.037 TYP	
e1	1.800	2.000	0.071	0.079
L	0.550REF		0.022REF	
x	1.460TYP		0.057TYP	
y	0.650TYP		0.026 TYP	
z	0.500TYP		0.020TYP	
θ	0°	8°	0°	8°



PACKAGE DESIGNATOR

(HEX6325SN) SOT-553

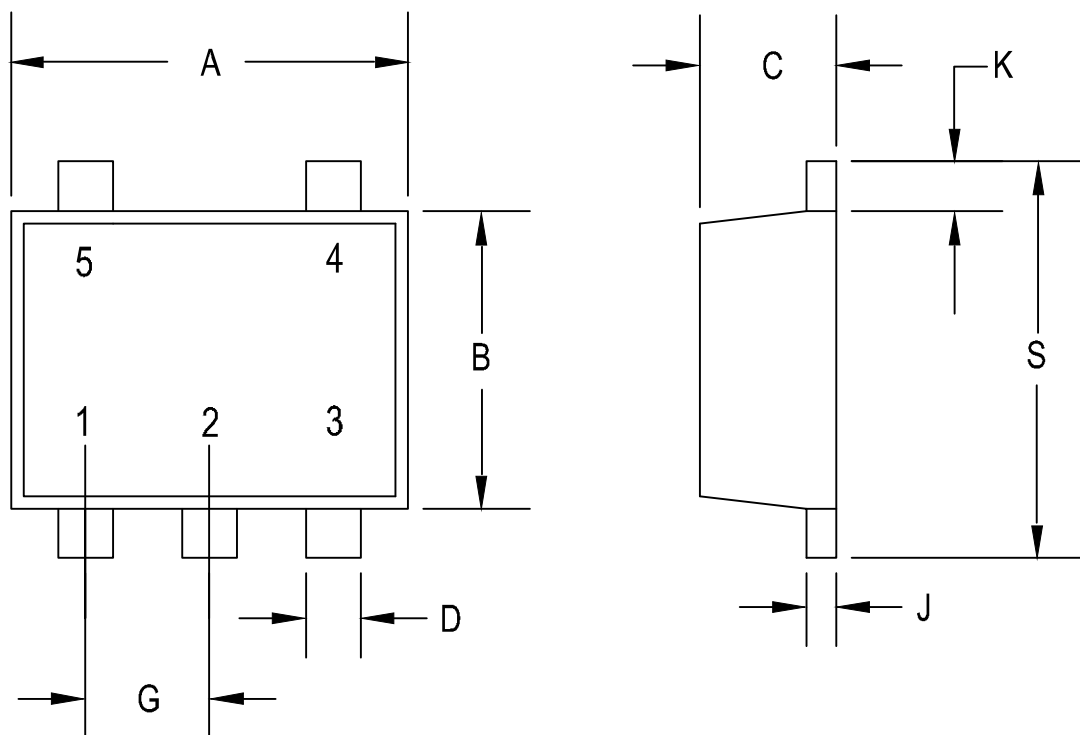

Symbol	Dimensions in Millimeters		Dimensions in Inches	
	Min	Max	Min	Max
A	1.500	1.700	0.059	0.067
B	1.100	1.300	0.043	0.051
C	0.525	0.600	0.021	0.024
D	0.170	0.270	0.007	0.011
G	0.450	0.550	0.018	0.022
J	0.090	0.160	0.004	0.006
K	0.100	0.300	0.004	0.012
S	1.500	1.700	0.059	0.067